

OTHER SHAPE :-

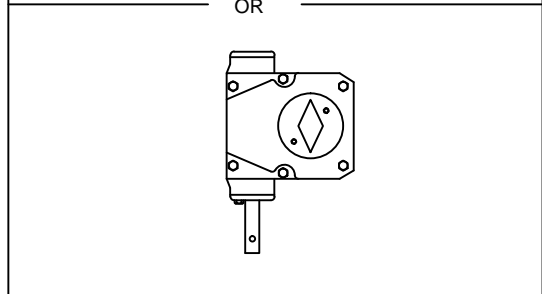
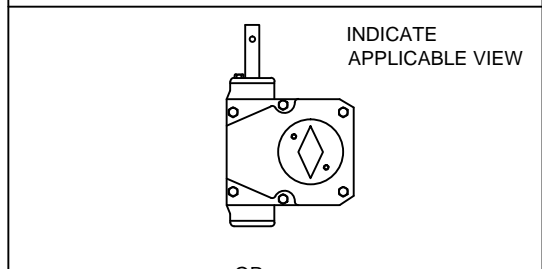
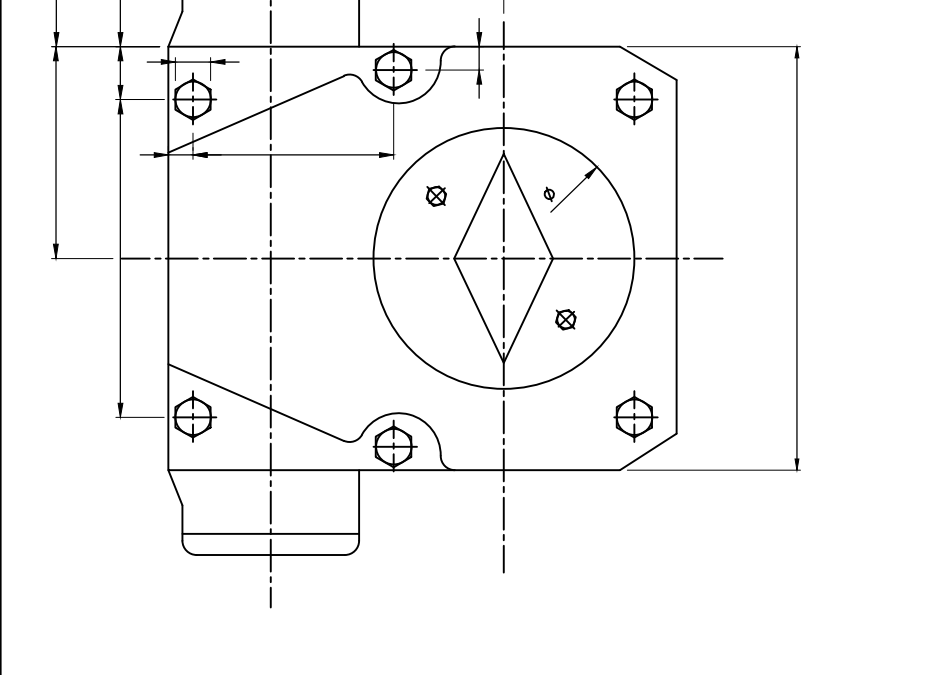
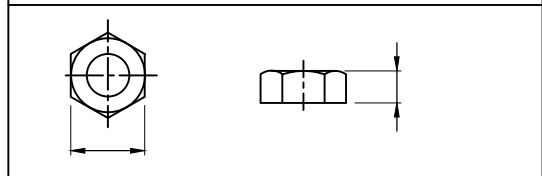
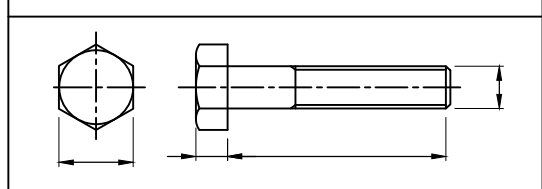
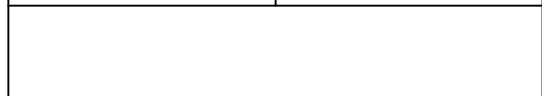
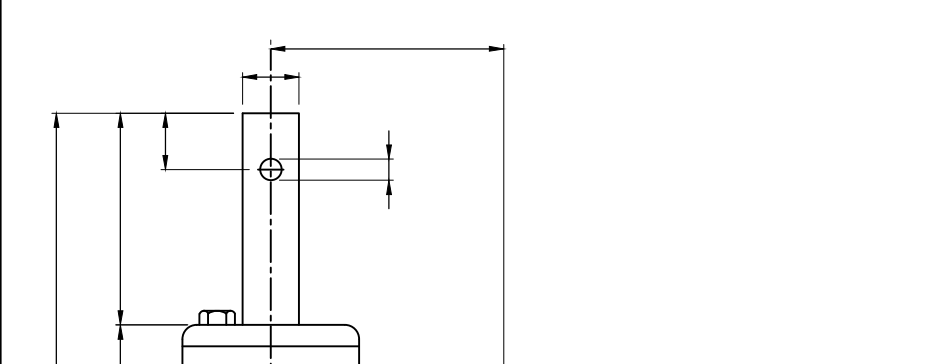

Measured by :- _____ Date :- _____

PETRO SAFE SYSTEMS (PSS)
 (DIVISION OF PETROMECH ENGG.PVT.LTD)
 OFFICE : 605,6th Floor, South Block, Sacred World
 Wanowari pune - 411040 (India)
 Tel : + 91-20-40053907/08/09 Fax : +91-20-40053911
 Email : procurement@petromek.in Website : www.petromek.in

Brand / Make :- _____

Model:- _____

Number of Turns:- _____

CLIENT :- _____

PROJECT :- _____

P.O.NO:- _____

Valve / Tagno :- _____